

Mounting Instruction

Product Parameters

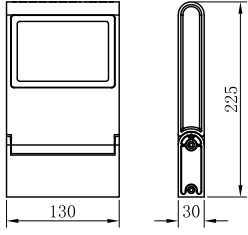

1. Model: 3057
2. Rated Voltage: AC 100-240V
3. Rated Power: LED 12W
4. IP Grade: IP54
5. Insulation protection level: Class I
6. Operating Temperature: $-30\sim+45^{\circ}\text{C}$

Components and Tools

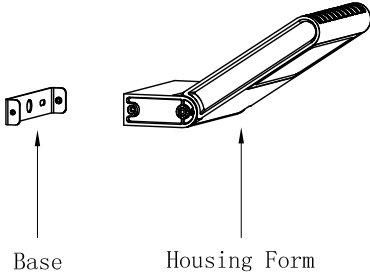

Base

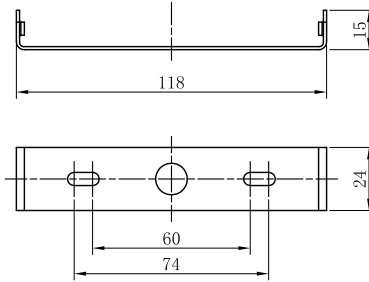

Mounting holes

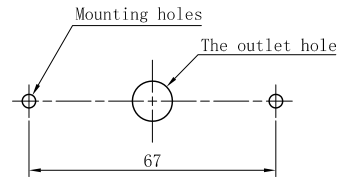

Installation Steps

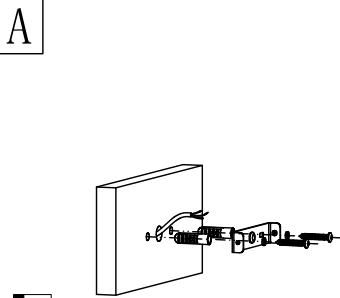

OFF

▲ Please be sure to fasten tightly of the base.

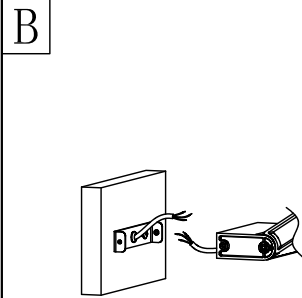

▲ Wiring must be operated in accordance with construction specifications.

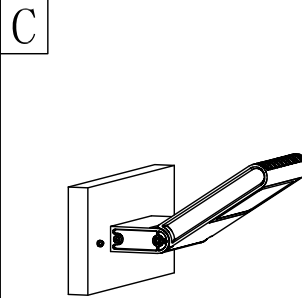

▲ Make sure the screws be fixed tightly.

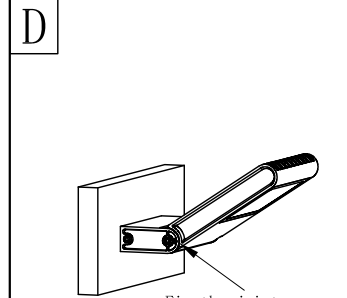

Fix the joint screw

▲ Adjust the angle of lamp.

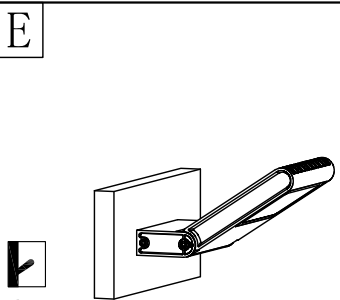

ON



▲ Connect the power supply, and light up the lamp.

Attention

1. Lamp should be installed by professional electrician;
2. The light source contained in this luminaire shall only be replaced by the manufacturer or his service agent or a similar qualified person;
3. Check the power switch has been turned off;

4. Please read this user guide carefully before installation and keep for future reference;
5. If the external flexible cable or cord of this luminaire is damaged, it shall be exclusively replaced by the manufacturer or his service agent or a similar qualified person in order to avoid a hazard.