

Mounting Instruction

Product Parameters

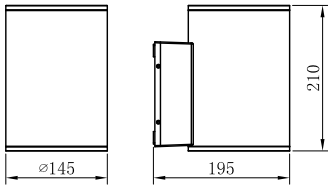

1. Model: 813074
2. Rated Voltage: AC 100-240V
3. Rated Power: LED 20W
4. IP Grade: IP65
5. Insulation protection level: Class I
6. Operating Temperature: $-30^{\circ}\text{C} \sim +45^{\circ}\text{C}$

Components and Tools

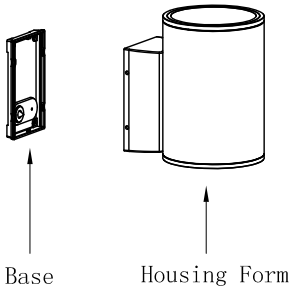

Base

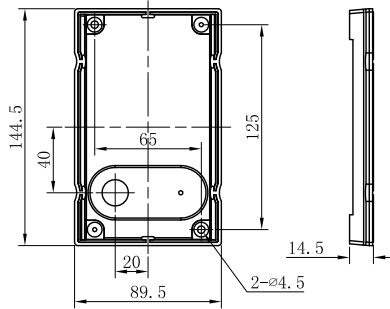

Mounting holes

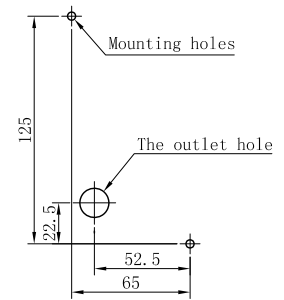

Installation Steps

A

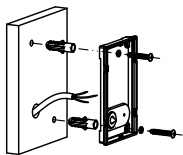

OFF

▲ Please be sure to fasten tightly of the base.

B

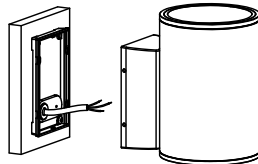

▲ Wiring must be operated in accordance with construction specifications.

C

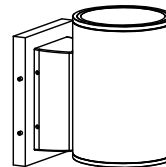

▲ Make sure the screws be fixed tightly.

D

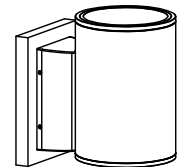

ON



▲ Connect the power supply, and light up the lamp.

E

F

G

H

Notes:

1. Read this manual of instructions carefully before installation and keep it for future reference;
2. The lamps should be installed or repaired by professional electricians;
3. The light source of this lamp should be replaced by the manufacturer or its service agent or a similarly qualified person;
4. If the external flexible cord of this lamp is damaged, for the sake of avoiding hazard the cord should be replaced by the manufacturer or its service agent or a similarly qualified person;
5. Check the power switch has been turned off before install or repair the lamp.