

Mounting Instruction

Product Parameters

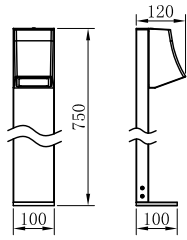

1. Model: 3337-75
2. Rated Voltage: AC 100-240V
3. Rated Power: LED 8W
4. IP Grade: IP65
5. Insulation protection level: Class I
6. Operating Temperature: -30~+45°C

Components and Tools

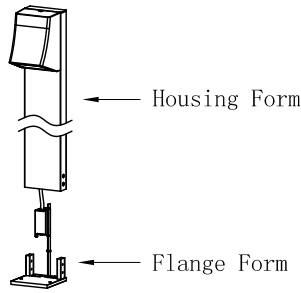

Flange

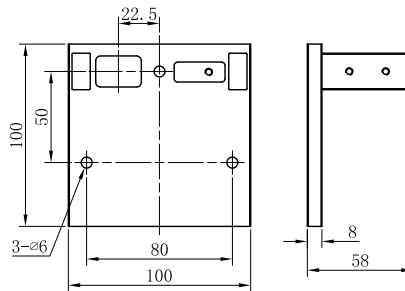

Mounting holes

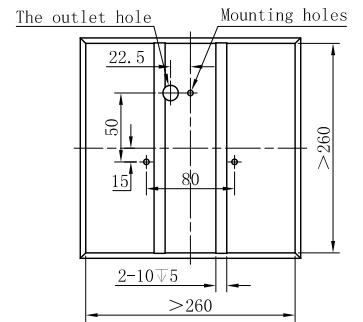

Installation Steps

A

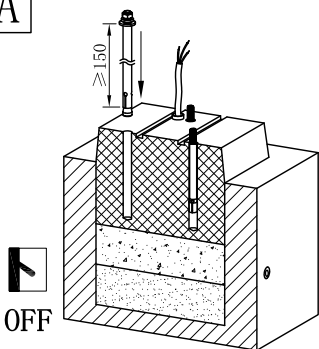

- ▲ The depth of foundation pit shall be determined by digging to the original soil. In case of backfill, the recessed box can be embedded only after water injection and settlement.
- ▲ After the concrete settling for 72H (3 days), shall the lamp be mounted only when the concrete is completely solidified.

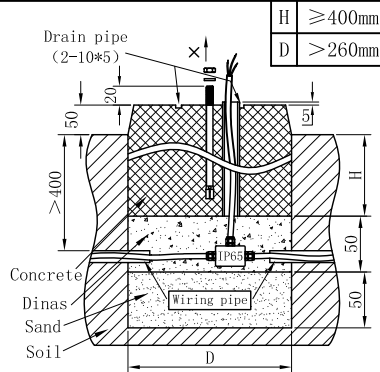

B

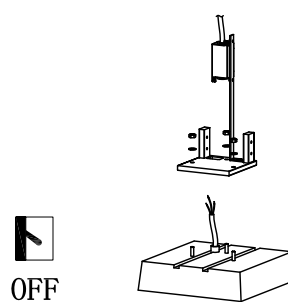

- ▲ Please be sure to fasten tightly of the flange.

C

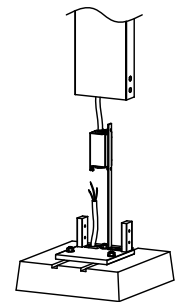

- ▲ Wiring must be operated in accordance with construction specifications.

D

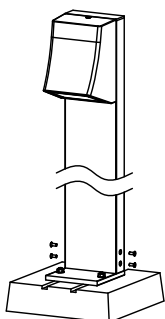

- ▲ Make sure the screws be fixed tightly.

E

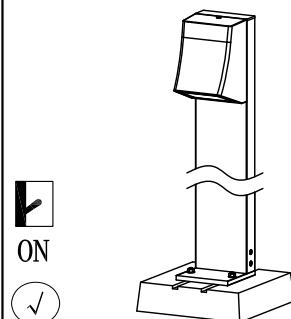

- ▲ Connect the power supply, and light up the lamp.

F

G

Notes:

1. Read this manual of instructions carefully before installation and keep it for future reference;
2. The lamps should be installed or repaired by professional electricians;
3. The light source of this lamp should be replaced by the manufacturer or its service agent or a similarly qualified person;
4. If the external flexible cord of this lamp is damaged, for the sake of avoiding hazard the cord should be replaced by the manufacturer or its service agent or a similarly qualified person;
5. Check the power switch has been turned off before install or repair the lamp.