

Mounting Instruction

Product Parameters

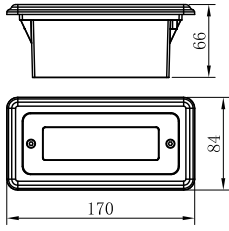

1. Model: 3862+B
2. Rated Voltage: AC 100-240V
3. Rated Power: LED 3W
4. IP Grade: IP65
5. Insulation protection level: Class I
6. Operating Temperature: $-30\sim+45^{\circ}\text{C}$

Components and Tools

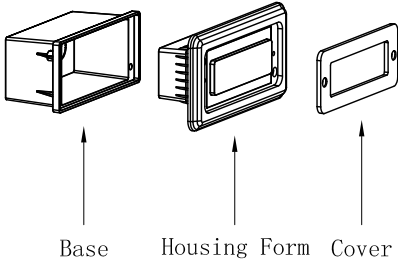

Recessed Box

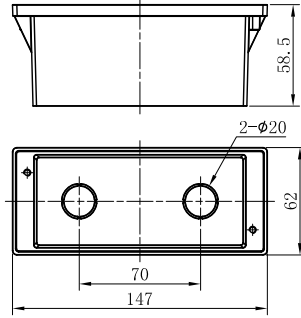

Mounting holes

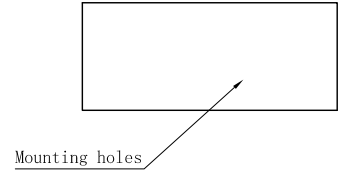

Installation Steps

A

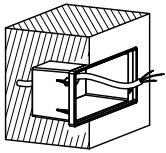

OFF

▲ The recessed box must be fixed tightly.

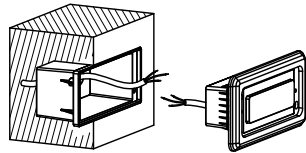

▲ Wiring must be operated in accordance with construction specifications.

B

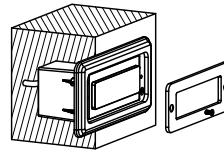

▲ Make sure the screws be fixed tightly.

C

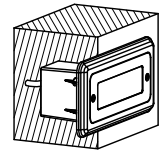

ON



▲ Connect the power supply, and light up the lamp.

D

E

F

G

Attention

1. Lamp should be installed by professional electrician;
2. The light source contained in this luminaire shall only be replaced by the manufacturer or his service agent or a similar qualified person;
3. Check the power switch has been turned off;
4. Please read this user guide carefully before installation and keep for future reference;
5. If the external flexible cable or cord of this luminaire is damaged, it shall be exclusively replaced by the manufacturer or his service agent or a similar qualified person in order to avoid a hazard.