

# Mounting Instruction

## Product Parameters

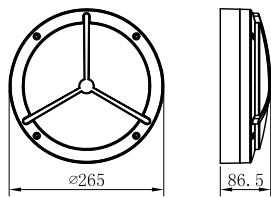

1. Model: 013110M
2. Rated Voltage: AC 100-240V
3. Rated Power: LED 16W
4. IP Grade: IP65
5. Insulation protection level: Class I
6. Operating Temperature: -30~+45°C

## Components and Tools

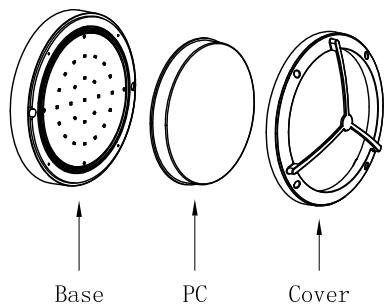

Base

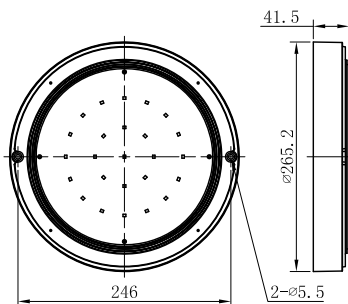

Mounting holes

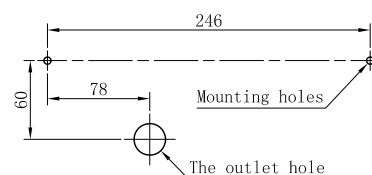

## Installation Steps

A

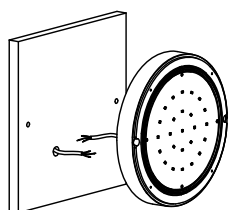

OFF

▲ Wiring must be operated in accordance with construction specifications.

B

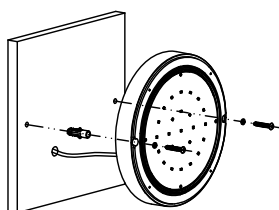

▲ Please be sure to fasten tightly of the base.

C

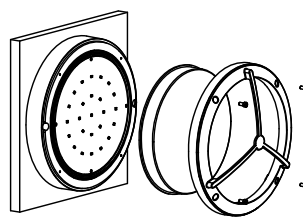

▲ Should be used diagonal way to lock screws by twice;  
 ①. At first, please lock the screws half;  
 ②. Secondly, lock the screws tightly.

D

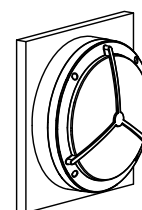

ON



▲ Connect the power supply, and light up the lamp.

E

F

G

H

## Notes:

1. Read this manual of instructions carefully before installation and keep it for future reference;
2. The lamps should be installed or repaired by professional electricians;
3. The light source of this lamp should be replaced by the manufacturer or its service agent or a similarly qualified person;
4. If the external flexible cord of this lamp is damaged, for the sake of avoiding hazard the cord should be replaced by the manufacturer or its service agent or a similarly qualified person;
5. Check the power switch has been turned off before install or repair the lamp.